

N-Channel Enhancement Mode Field Effect Transistor

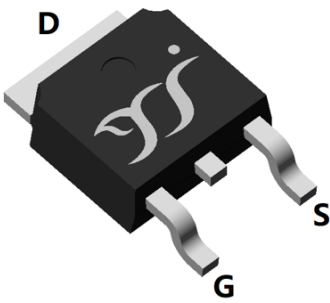

Top View

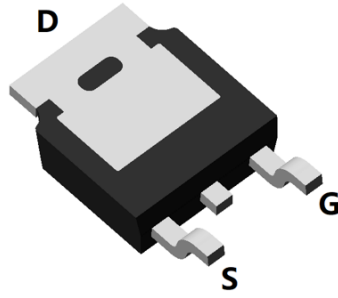

Bottom View

TO-252

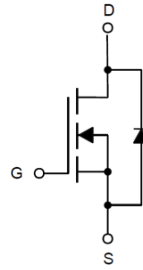

Product Summary

- V_{DS} 30V
- I_D 80A
- $R_{DS(ON)}$ (at $V_{GS}=10V$) <4.9mohm
- $R_{DS(ON)}$ (at $V_{GS}=4.5V$) <7.0mohm
- 100% EAS Tested
- 100% ∇V_{DS} Tested

General Description

- Trench Power LV MOSFET technology
- Excellent package for heat dissipation
- High density cell design for low $R_{DS(ON)}$
- Moisture Sensitivity Level 1
- Epoxy Meets UL 94 V-0 Flammability Rating
- Halogen Free

Applications

- High current load applications
- Load switch
- Hard switched and high frequency circuits
- Uninterruptible power supply

■ Absolute Maximum Ratings ($T_A=25^\circ\text{C}$ unless otherwise noted)

Parameter		Symbol	Limit	Unit
Drain-source Voltage		V_{DS}	30	V
Gate-source Voltage		V_{GS}	± 20	V
Drain Current	$T_C=25^\circ\text{C}$	I_D	80	A
	$T_C=100^\circ\text{C}$		50	
Pulsed Drain Current ^A		I_{DM}	190	A
Single Pulse Avalanche Energy ^B		E_{AS}	100	mJ
Total Power Dissipation ^C	$T_C=25^\circ\text{C}$	P_D	38	W
	$T_C=100^\circ\text{C}$		15	
Thermal Resistance Junction-to-Ambient ^D		$R_{\theta JA}$	60	$^\circ\text{C}/\text{W}$
Thermal Resistance Junction-to-Case		$R_{\theta JC}$	3.3	
Junction and Storage Temperature Range		T_J, T_{STG}	-55~+150	$^\circ\text{C}$

■ Ordering Information (Example)

PREFERRED P/N	PACKING CODE	Marking	MINIMUM PACKAGE(pcs)	INNER BOX QUANTITY(pcs)	OUTER CARTON QUANTITY(pcs)	DELIVERY MODE
YJD80N03B	F1/F2	YJD80N03B	2500	/	25000	13" reel



YJD80N03B

■ Electrical Characteristics (T_J=25°C unless otherwise noted)

Parameter	Symbol	Conditions	Min	Typ	Max	Units
Static Parameter						
Drain-Source Breakdown Voltage	BV _{DSS}	V _{GS} = 0V, I _D =250μA	30			V
Zero Gate Voltage Drain Current	I _{DSS}	V _{DS} =30V, V _{GS} =0V			1	μA
Gate-Body Leakage Current	I _{GSS}	V _{GS} = ±20V, V _{DS} =0V			±100	nA
Gate Threshold Voltage	V _{GS(th)}	V _{DS} = V _{GS} , I _D =250μA	1	1.5	2.5	V
Static Drain-Source On-Resistance	R _{D(S)(ON)}	V _{GS} =10V, I _D =20A		3.4	4.9	mΩ
		V _{GS} = 4.5V, I _D =15A		5.4	7.0	
Diode Forward Voltage	V _{SD}	I _S =20A, V _{GS} =0V		0.85	1.2	V
Gate resistance	R _G	f=1MHz, Open drain	-	2.7	-	Ω
Maximum Body-Diode Continuous Current	I _S				80	A
Dynamic Parameters						
Input Capacitance	C _{iss}	V _{DS} =15V, V _{GS} =0V, f=1MHZ		2191		pF
Output Capacitance	C _{oss}			300		
Reverse Transfer Capacitance	C _{rss}			247		
Switching Parameters						
Total Gate Charge	Q _g	V _{GS} =10V, V _{DS} =15V, I _D =20A		46.3		nC
Gate-Source Charge	Q _{gs}			8.8		
Gate-Drain Charge	Q _{gd}			9.2		
Reverse Recovery Chrage	Q _{rr}	I _r =20A, di/dt=100A/us		1.6		
Reverse Recovery Time	t _{rr}			11		
Turn-on Delay Time	t _{D(on)}	V _{GS} =10V, V _{DD} =15V, R _L =0.75Ω R _{GEN} =3Ω		11		ns
Turn-on Rise Time	t _r			80		
Turn-off Delay Time	t _{D(off)}			39		
Turn-off fall Time	t _f			92		

A. Repetitive rating; pulse width limited by max. junction temperature.

B. T_J=25°C, V_{DD}=50V, V_G=10V, R_G=25Ω, L=0.5mH, I_{AS}=20A.

C. P_d is based on max. junction temperature, using junction-case thermal resistance.

D. The value of R_{θJA} is measured with the device mounted on the minimum recommend pad size, in the still air environment with T_A =25°C. The maximum allowed junction temperature of 150°C. The value in any given application depends on the user's specific board design.



■ Typical Performance Characteristics

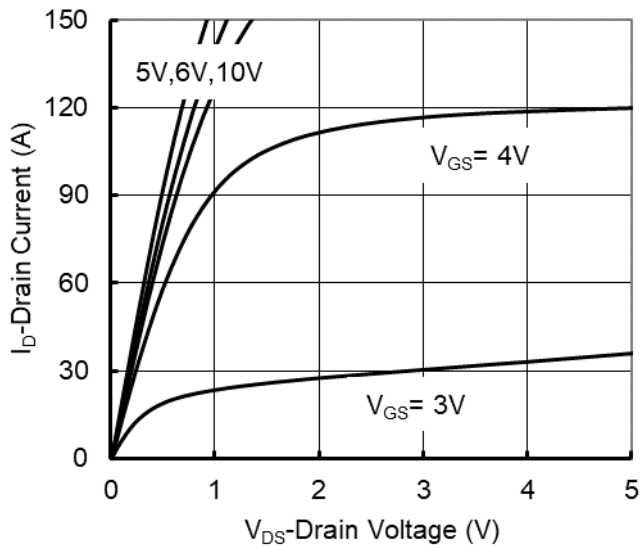

Figure 1. Output Characteristics

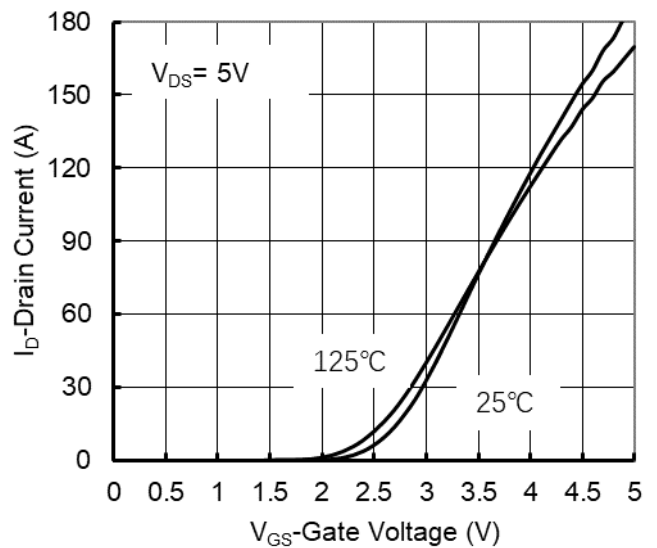

Figure 2. Transfer Characteristics

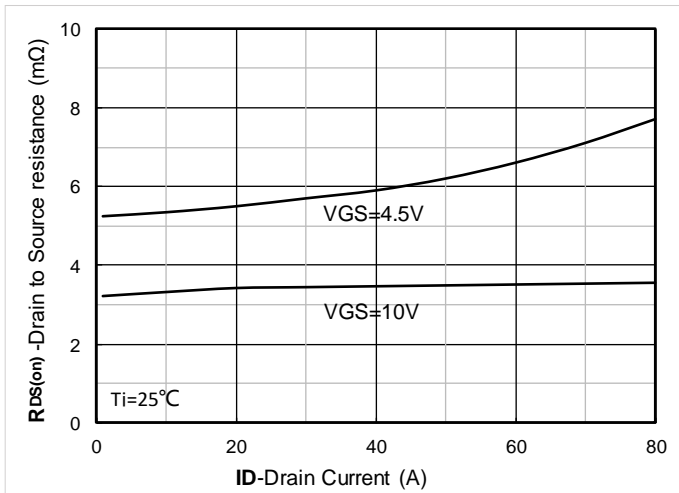

Figure 3. On-Resistance vs. Drain Current and Gate Voltage

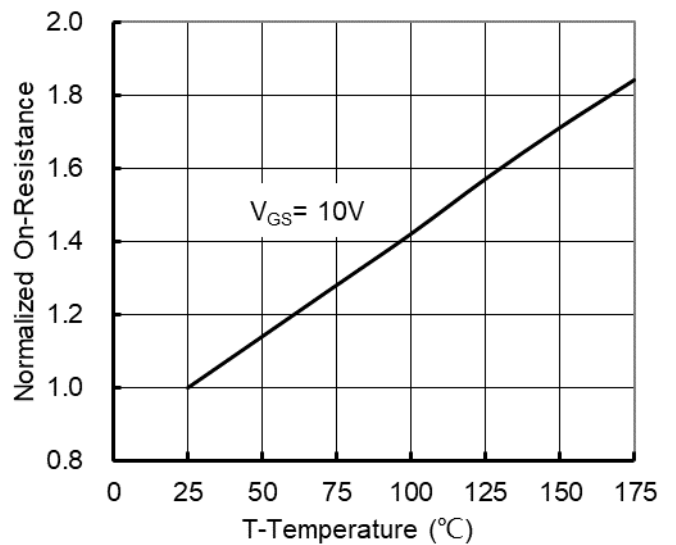

Figure 4. On-Resistance vs. Junction Temperature

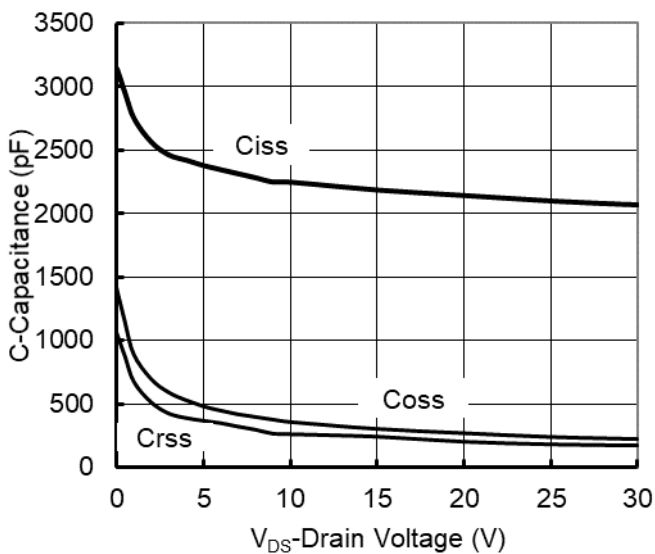

Figure 5. Capacitance Characteristics

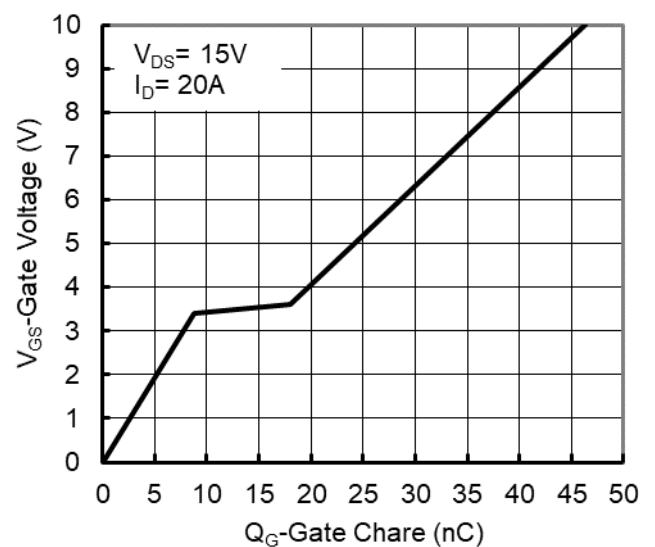

Figure 6. Gate Charge

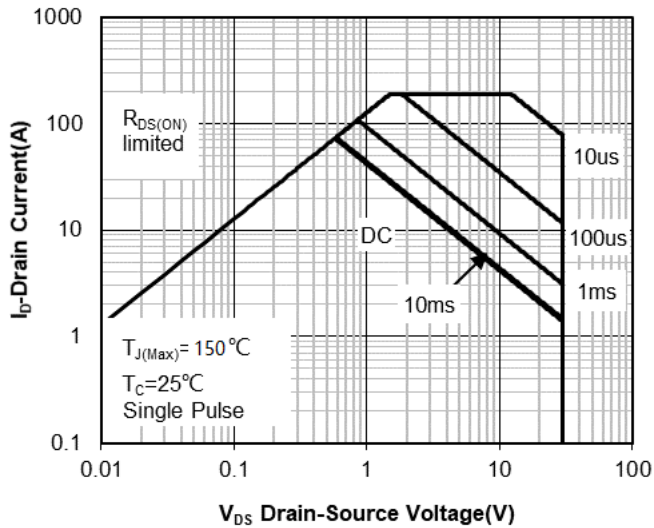

Figure 7. Safe Operation Area

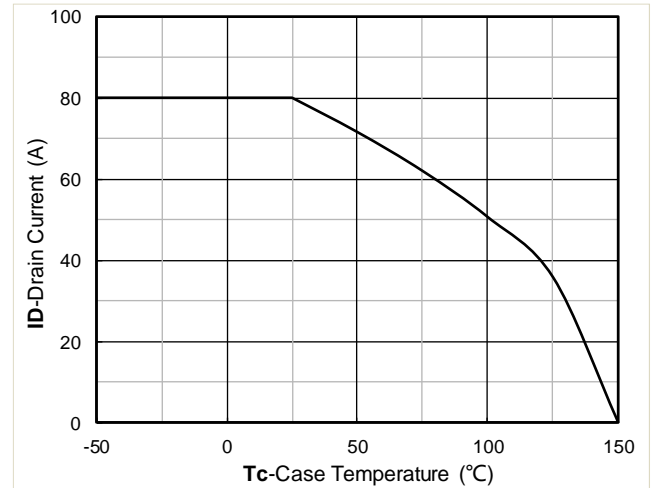

Figure 8. Maximum Continuous Drain Current vs Case Temperature

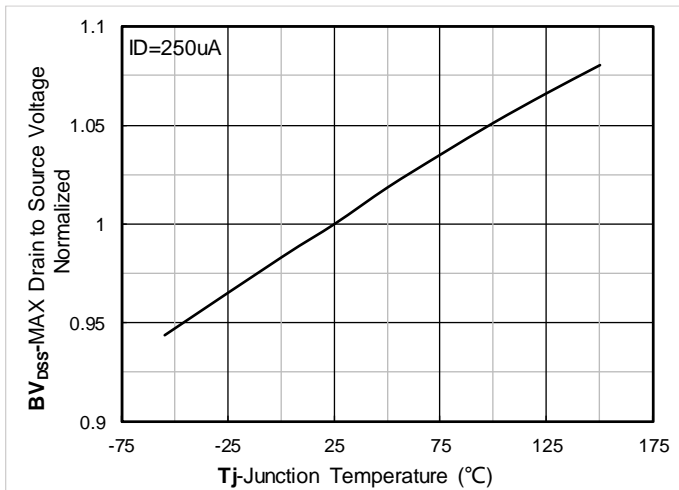

Figure 9. Normalized breakdown voltage

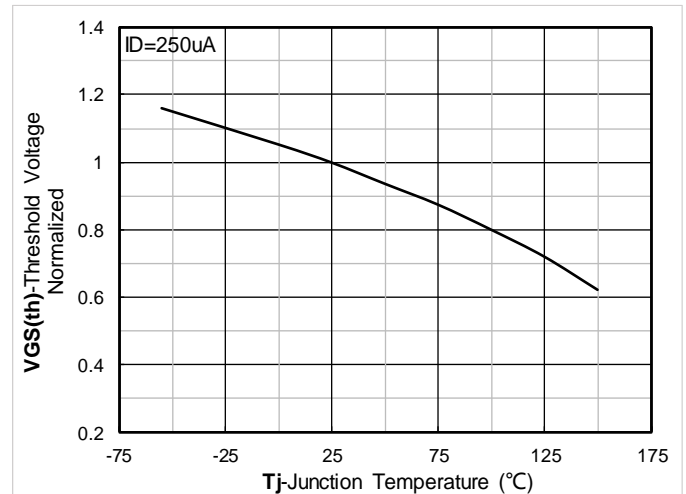

Figure 10. Normalized Threshold voltage

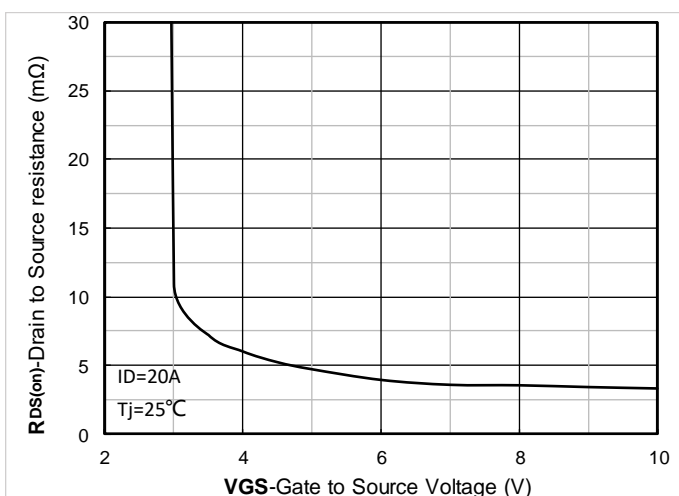

Figure 11. On-Resistance vs Gate to Source Voltage

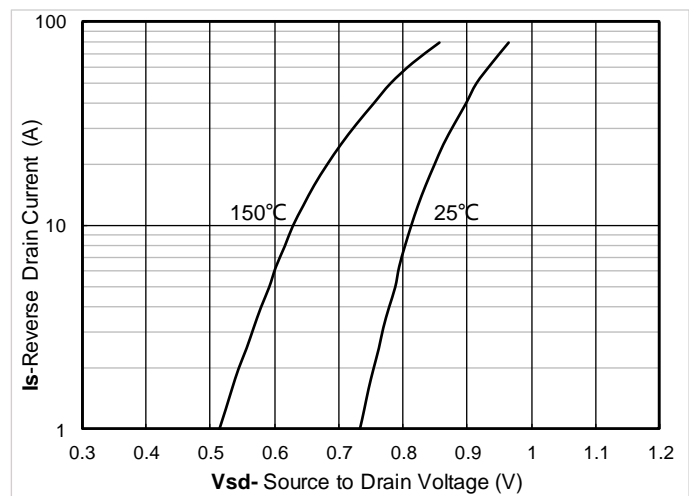

Figure 12. Forward characteristics of reverse diode



YJD80N03B

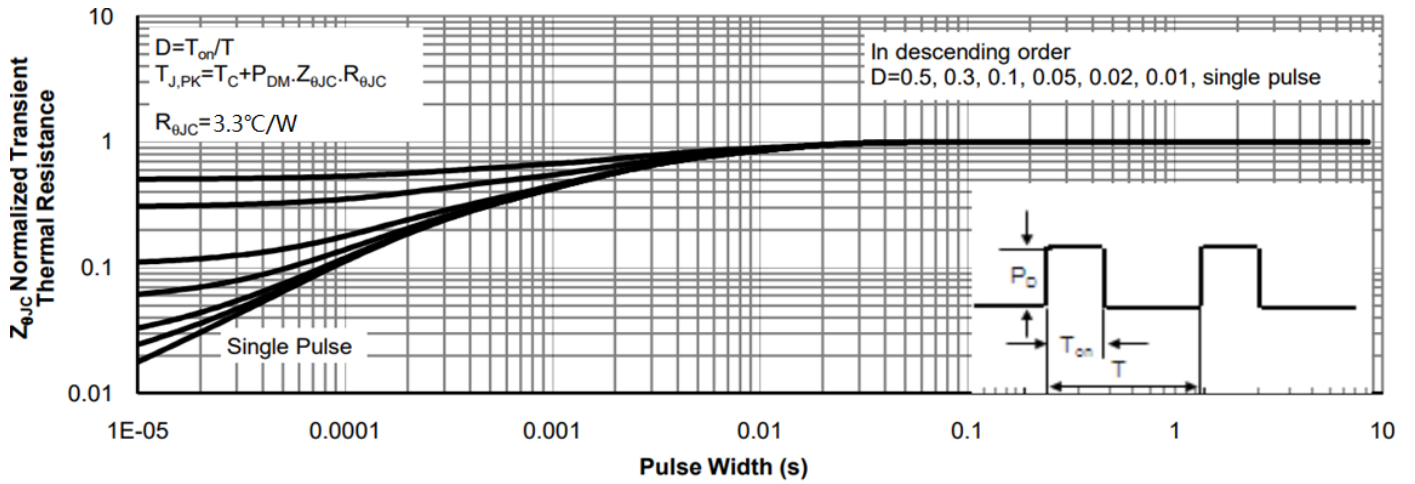
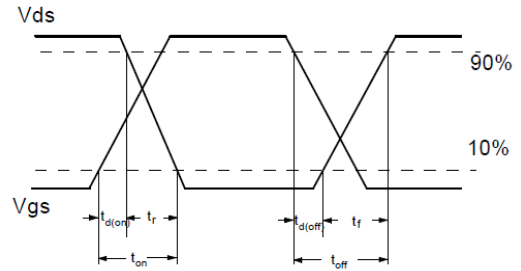
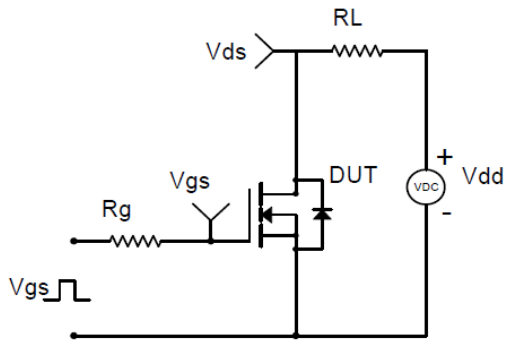
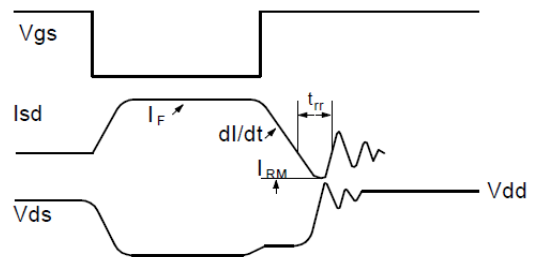
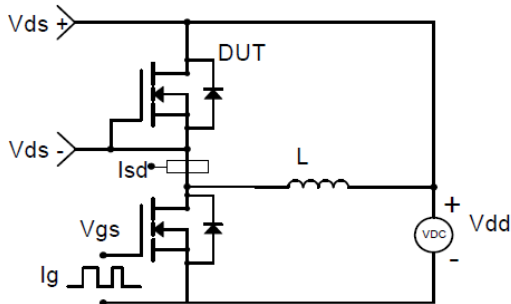

Figure 13. Normalized Maximum Transient Thermal Impedance



Resistive Switching Test Circuit & Waveforms



Diode Recovery Test Circuit & Waveforms

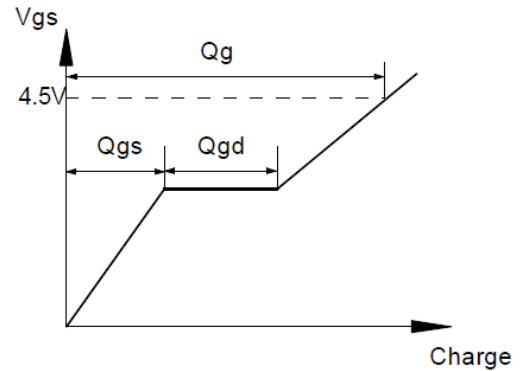
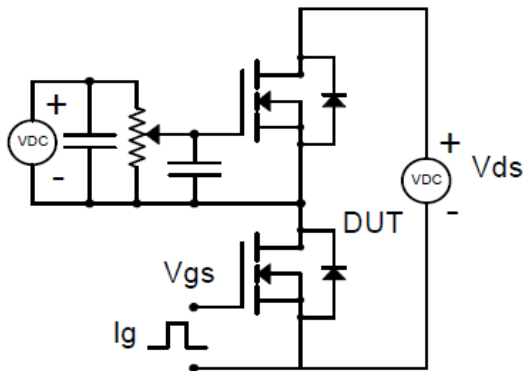

Gate Charge Test Circuit & Waveform

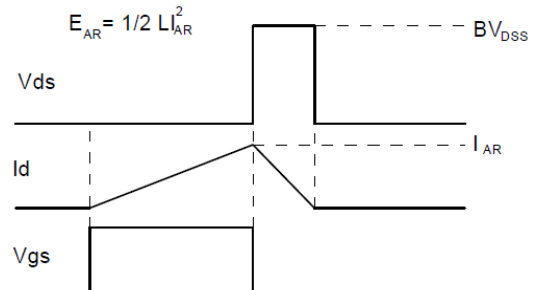
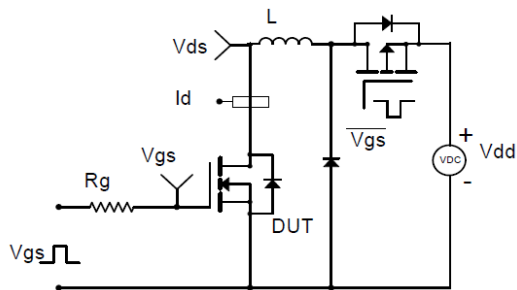

Unclamped Inductive Switching (UIS) Test Circuit & Waveforms



YJD80N03B

TO-252-B Package information

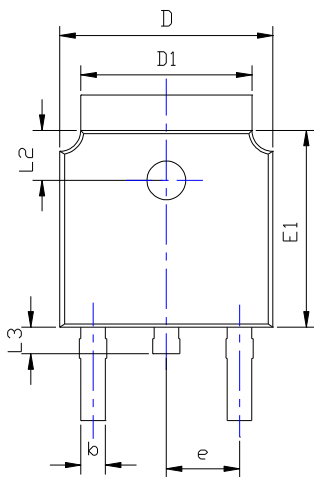

TOP VIEW

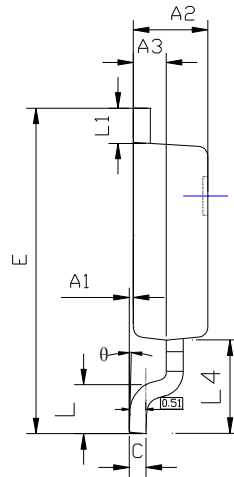

SIDE VIEW

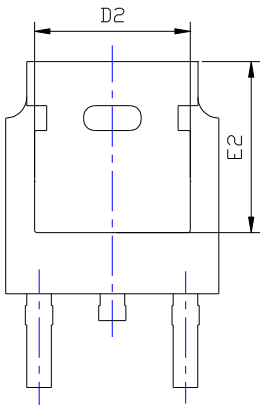

BOTTOM VIEW

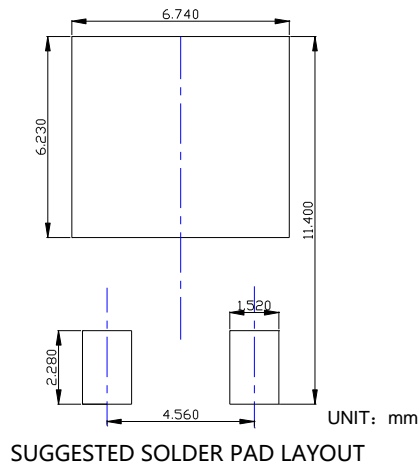

SYMBOL	DIMENSIONS					
	INCHES			Millimeter		
	MIN.	NOM.	MAX.	MIN.	NOM.	MAX.
A1	0.000	---	0.008	0.000	---	0.200
A2	0.087	0.091	0.094	2.200	2.300	2.400
A3	0.035	0.039	0.043	0.900	1.000	1.100
b	0.026	0.030	0.034	0.660	0.760	0.860
c	0.018	0.020	0.023	0.460	0.520	0.580
D	0.256	0.260	0.264	6.500	6.600	6.700
D1	0.203	0.209	0.215	5.150	5.300	5.450
D2	0.181	0.189	0.195	4.600	4.800	4.950
E	0.390	0.398	0.406	9.900	10.100	10.300
E1	0.236	0.240	0.244	6.000	6.100	6.200
E2	0.203	0.209	0.215	5.150	5.300	5.450
e	0.090BSC			2.286BSC		
L	0.049	0.059	0.069	1.250	1.500	1.750
L1	0.035	---	0.050	0.900	---	1.270
L2	0.055	---	0.075	1.400	---	1.900
L3	0.240	0.310	0.039	0.600	0.800	1.000
L4	0.114REF			2.900REF		
θ	0°	---	10°	0°	---	10°

NOTE:

- 1.PACKAGE BODY SIZES EXCLUDE MOLD FLASH AND GATE BURRS.
- 2.TOLERANCE 0.1mm UNLESS OTHERWISE SPECIFIED.
- 3.THE PAD LAYOUT IS FOR REFERENCE PURPOSES ONLY.



YJD80N03B

Disclaimer

The information presented in this document is for reference only. Yangzhou Yangjie Electronic Technology Co., Ltd. reserves the right to make changes without notice for the specification of the products displayed herein to improve reliability, function or design or otherwise.

The product listed herein is designed to be used with ordinary electronic equipment or devices, and not designed to be used with equipment or devices which require high level of reliability and the malfunction of which would directly endanger human life (such as medical instruments, transportation equipment, aerospace machinery, nuclear-reactor controllers, fuel controllers and other safety devices), Yangjie or anyone on its behalf, assumes no responsibility or liability for any damages resulting from such improper use of sale.

This publication supersedes & replaces all information previously supplied. For additional information, please visit our website [http:// www.21yangjie.com](http://www.21yangjie.com) , or consult your nearest Yangjie's sales office for further assistance.