

## NPN Transistor

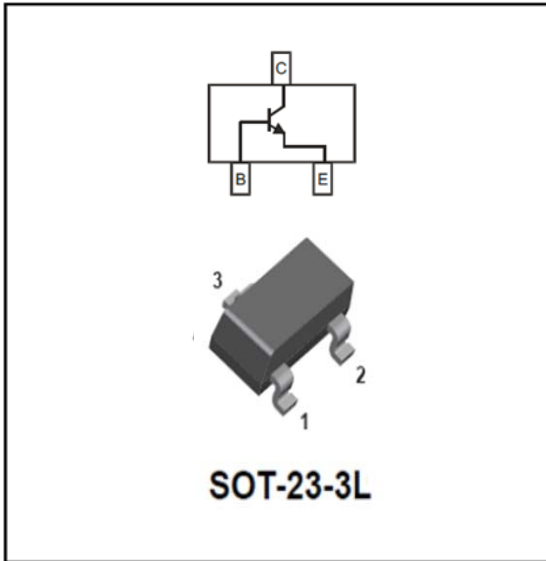

### Features

- Epoxy meets UL-94 V-0 flammability rating
- Halogen free available upon request by adding suffix "HF"
- Moisture Sensitivity Level 1
- Surface mount package ideally Suited for Automatic Insertion
- NPN

### Mechanical Data

- **Package:** SOT-23-3L
- **Terminals:** Tin plated leads, solderable per J-STD-002 and JESD22-B102
- **Marking:**

2SC3052K-E	LE
2SC3052K-F	LF
2SC3052K-G	LG

### ■ Maximum Ratings (Ta=25°C unless otherwise noted)

Item	Symbol	Unit	Conditions	Value
Collector-Base Voltage	$V_{CBO}$	V	$I_C=100\mu A, I_E=0$	50
Collector-Emitter Voltage	$V_{CEO}$	V	$I_C=100\mu A, I_B=0$	50
Emitter-Base Voltage	$V_{EBO}$	V	$I_E=100\mu A, I_C=0$	6
Collector Current	$I_C$	A		0.2
Collector Power Dissipation	$P_C$	mW		150
Operation Junction Temperature	$T_j$	°C		150
Storage Temperature	$T_{stg}$	°C		-55 to +150

### ■ Electrical Characteristics (Ta=25°C unless otherwise noted)

Item	Symbol	Unit	Conditions	Min	Type	Max
Collector-base breakdown voltage	$V_{CBO}$	V	$I_C=100\mu A, I_E=0$	50		
Collector-emitter breakdown voltage	$V_{CEO}$	V	$I_C=100\mu A, I_B=0$	50		
Emitter-base breakdown voltage	$V_{EBO}$	V	$I_E=100\mu A, I_C=0$	6		
Collector-base cut-off current	$I_{CBO}$	$\mu A$	$V_{CB}=50 V, I_E=0$			0.1
Emitter-base cut-off current	$I_{EBO}$	$\mu A$	$V_{EB}=6 V, I_C=0$			0.1
DC current gain	$h_{FE1}$		$V_{CE}=6V, I_C=1mA$	150		800
	$h_{FE2}$		$V_{CE}=6V, I_C=0.1mA$	50		
Collector-emitter saturation voltage	$V_{CE(sat)}$	V	$I_C=100mA, I_B=10mA$			0.3
Base-emitter saturation voltage	$V_{BE(sat)*}$	V	$I_C=100mA, I_B=10mA$			1
Transition frequency	$f_T$	MHz	$V_{CE}=6V, I_C=10mA$		180	
Collector-base output capacitance	$C_{ob}$	pF	$V_{CB}=6V, I_E=0, f=1MHz$			4



## ■ CLASSIFICATION OF HFE

Rank	E	F	G
Range	150-300	250-500	400-800

## ■ Ordering Information (Example)

PREFERRED P/N	PACKING CODE	UNIT WEIGHT(g)	MINIMUM PACKAGE(pcs)	INNER BOX QUANTITY(pcs)	OUTER CARTON QUANTITY(pcs)	DELIVERY MODE
2SC3052K	F2	Approximate 0.014	3000	30000	120000	7" reel

## ■ Characteristics(Typical)

Static Characteristic

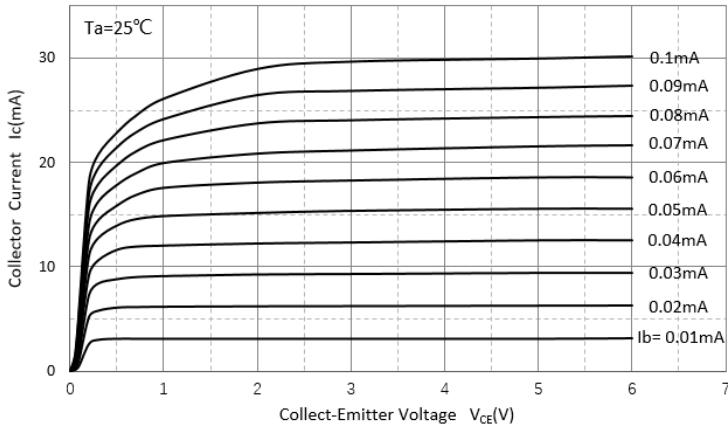

DC Current Gain

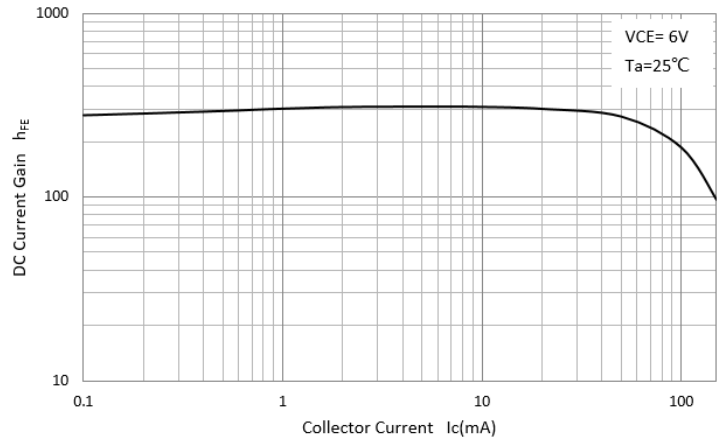

Collector-Emitter Saturation Voltage

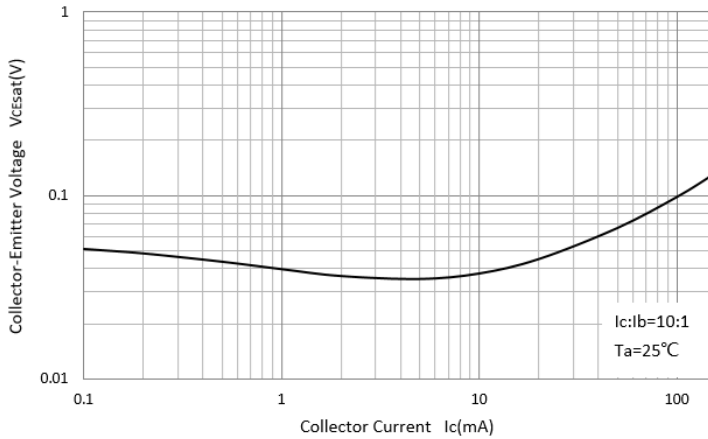

Base-Emitter Saturation Voltage

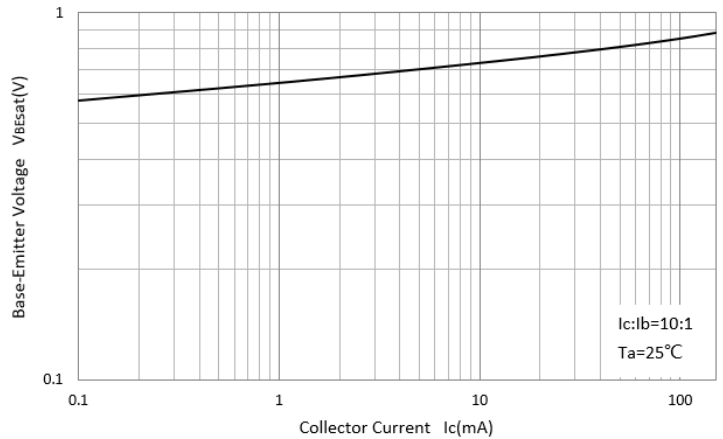

Base-Emitter On Voltage

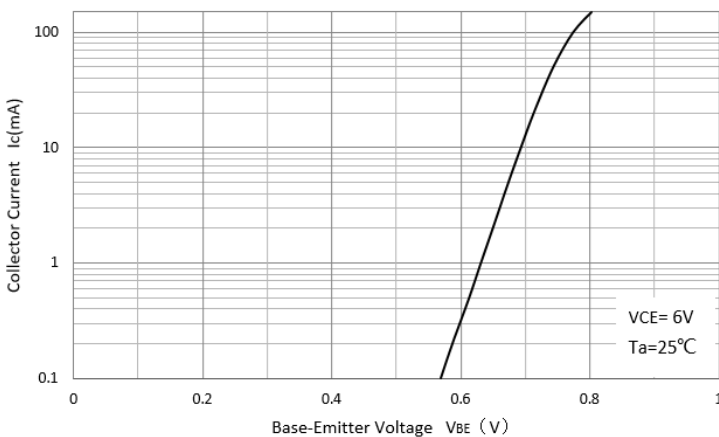

Cob/Cib-V<sub>CB</sub>/V<sub>EB</sub>

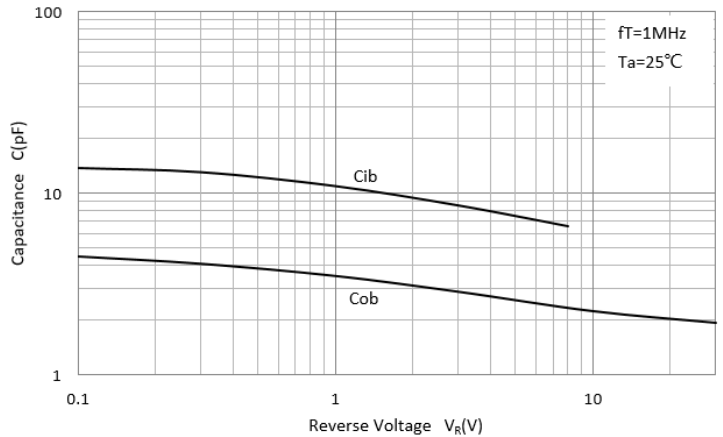

## ■SOT-23-3L Package Outline Dimensions

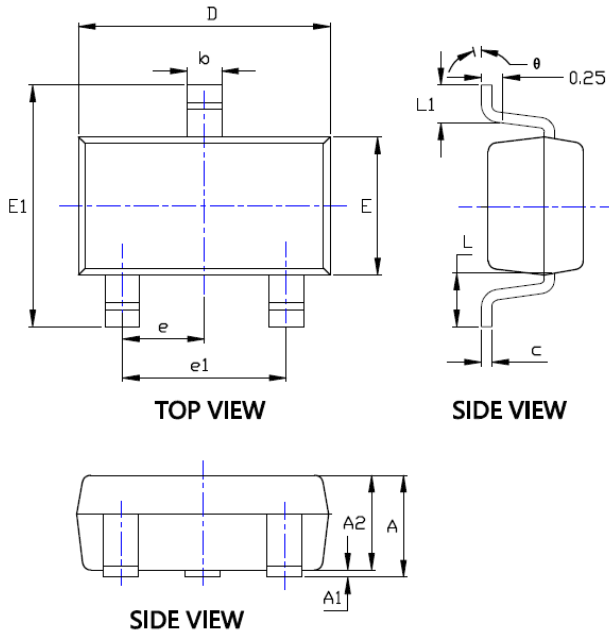

SYMBOL	DIMENSIONS			
	INCHES		Millimeter	
	MIN.	MAX.	MIN.	MAX.
A	0.041	0.049	1.050	1.250
A1	0.000	0.008	0.000	0.200
A2	0.041	0.045	1.050	1.150
b	0.012	0.020	0.300	0.500
c	0.004	0.008	0.100	0.200
D	0.111	0.119	2.820	3.020
E	0.059	0.067	1.500	1.700
E1	0.104	0.116	2.650	2.950
e	0.037TYP		0.950TYP	
e1	0.071	0.079	1.800	2.000
L	0.024REF		0.600REF	
L1	0.012	0.024	0.300	0.600
∅	0°	8°	0°	8°

## ■SOT-23-3L Soldering Footprint

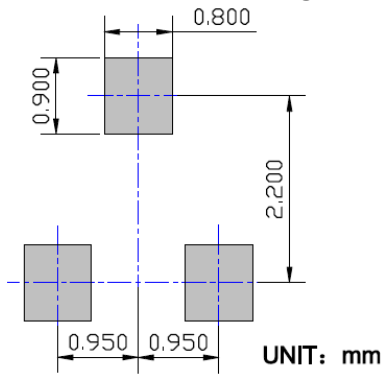



## Disclaimer

The information presented in this document is for reference only. Yangzhou Yangjie Electronic Technology Co., Ltd. reserves the right to make changes without notice for the specification of the products displayed herein to improve reliability, function or design or otherwise.

The product listed herein is designed to be used with ordinary electronic equipment or devices, and not designed to be used with equipment or devices which require high level of reliability and the malfunction of which would directly endanger human life (such as medical instruments, transportation equipment, aerospace machinery, nuclear-reactor controllers, fuel controllers and other safety devices), Yangjie or anyone on its behalf, assumes no responsibility or liability for any damages resulting from such improper use of sale.

This publication supersedes & replaces all information previously supplied. For additional information, please visit our website [http:// www.21yangjie.com](http://www.21yangjie.com) , or consult your nearest Yangjie's sales office for further assistance.